

MED8P53 is a low failure infrared point source LED die. It is optimized for optical switches and encoder applications due to its small-size emitting aperture.

Features

- Small-size emitting aperture ($\phi 60\mu\text{m}$)
- High output power
- High reliability

Structure

- Material: AlGaAs/GaAs sub.
- Electrode: Au alloy (p,n)
- Emitting surface: p-side

Applications

- Optical encoders
- Optical switches
- Optical sensors etc

Dimensional outline drawing(μm)

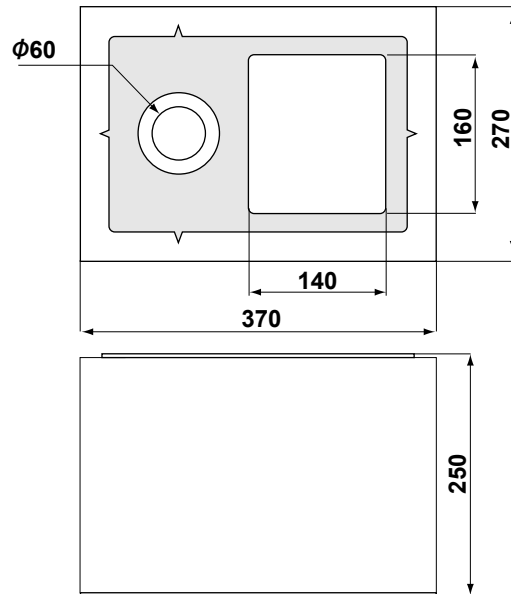

Absolute Maximum Ratings* ($T_a=25^\circ\text{C}$)

Parameter	Symbol	Rating	Unit
Forward Current	I_F	80	mA
Reverse Voltage	V_R	3	V
Operating Temperature	T_{opr}	-20~80	$^\circ\text{C}$
Storage Temperature	T_{stg}	-30~100	$^\circ\text{C}$

Electro-Optical Characteristics* ($T_a=25^\circ\text{C}$)

Parameter	Symbol	Condition	Min.	Typ.	Max.	Unit
Forward Voltage	V_F	$I_F=50\text{mA}$	-	2.0	2.4	V
Reverse Current	I_R	$V_R=3\text{V}$	-	-	10	μA
Output Power	P_o	$I_F=50\text{mA}$	1.2	2.0	-	mW
Central Wavelength	λ_c	$I_F=50\text{mA}$	-	855	-	nm
Cutoff Frequency	f_c	$I_F=50\text{mA}+20\text{mA p-p}$	-	45	-	MHz

*As mounted on T018 header and hermetically sealed

Fig1. I_F / T_a

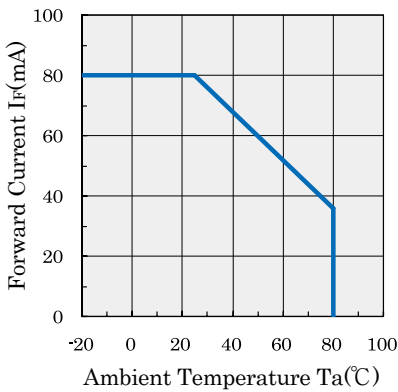

Fig2. I_F / V_F

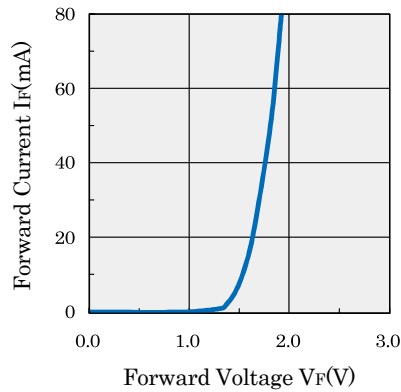

Fig3. V_F / T_a

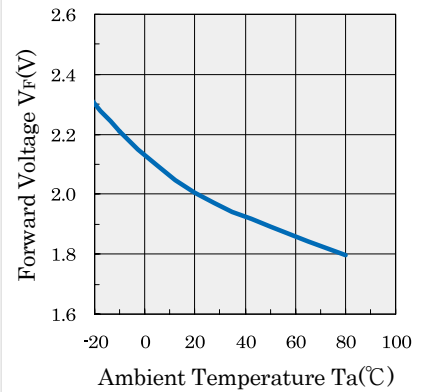

Fig4. P_O / I_F

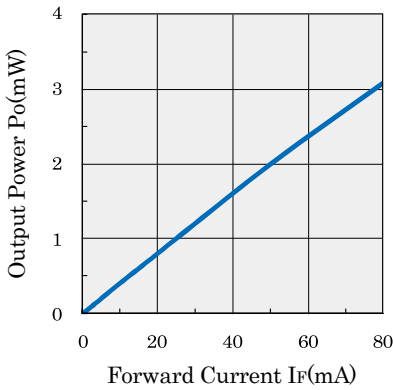

Fig5. Relative P_O / T_a

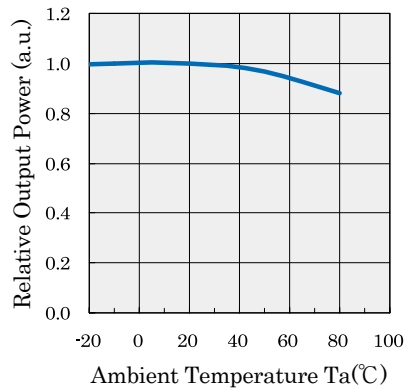

Fig6. Frequency Response

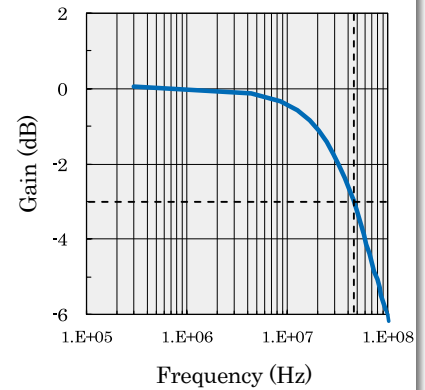

Fig7. Spectral Characteristics

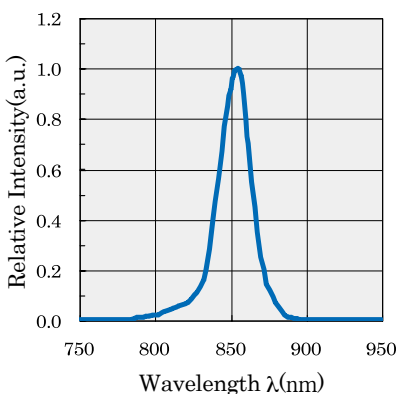

Fig8. Central Wavelength λ_c / T_a

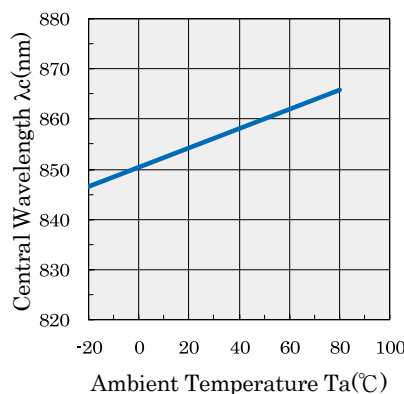
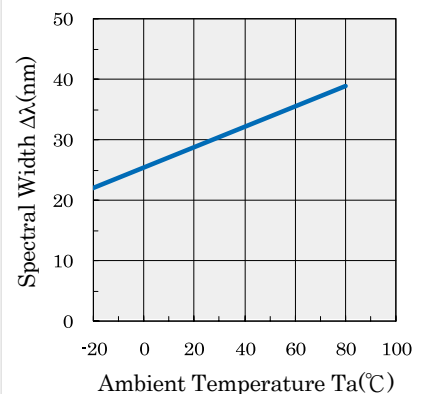

Fig9. Spectral Width $\Delta\lambda / T_a$



This catalogue was compiled in March 2023. All items listed in the catalogue are subject to change without any prior notice.

Products listed in this catalogue are designed and manufactured for use in standard applications (eg: household appliances, OA/AV, telecommunications, measurement instruments). The customers should take security measures, when used the products in critical reliability and security applications (eg: space and aviation, critical-safety transport applications, nuclear power control, medical, life-supporting units and equipment). We assume no liability for damages incurred by use of the products without taking measures described above.

